

Diaphragm Control Valves VC-210B Series

GENERAL DESCRIPTION

Model VC-210B Diaphragm Control Valves are compact, ruggedly constructed and especially designed for the control of water, steam, gas, vacuum, etc. Valves are single seated, bellows sealed to prevent stem leakage, and may be selected to have the valve action, seating materials and flow characteristics needed for most control applications.

The pneumatic actuator consists of a molded 10 sq. in. EPDM diaphragm enclosed in a die-cast aluminum housing and frame. The readily accessible spring adjusting nut provides easy field adjustment of the starting point within the selected spring range. Synthane gaskets located between the valve bonnet and the actuator frame reduce heat transfer to the diaphragm.

OUTSTANDING FEATURES

- Full Ported or Low Flow Designs
- Direct- and Reverse-Acting Valve Styles
- Molded Diaphragms
- "Packless" Stem Seal
- Two-Way and Three-Way Valves

SECONDARY O-RING
 STEM SEALS

PRIMARY SEAMLESS METAL
 BELLOWS STEM SEAL

STAINLESS STEEL TRIM

TEFLON* OR METAL-TO-
 METAL SEATING

PARTS PLATED OR SPECIALLY
 FINISHED FOR CORROSION RESISTANCE

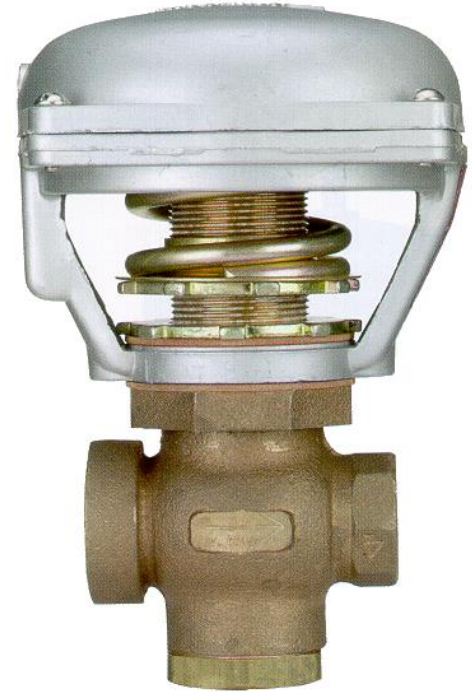
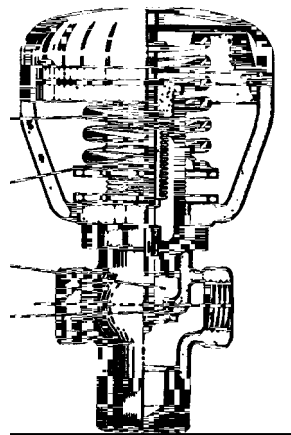

BRASS

TYPICAL APPLICATIONS

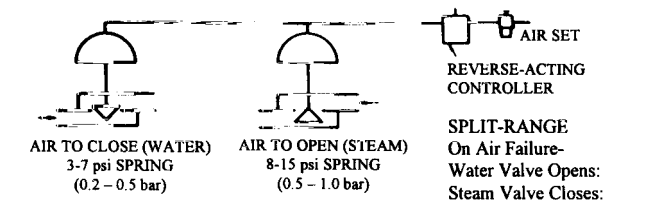
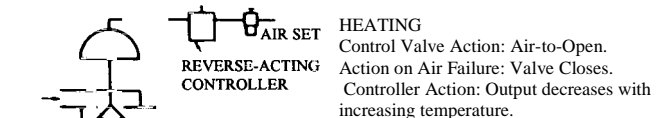
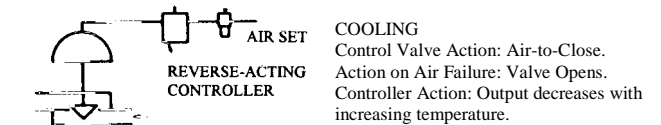

Note: Above configurations provide fail-safe action, i.e., on air failure a cooling valve will open and heating valve will close. If this valve action is not desired, then reverse above applications and use a direct-acting controller where a reverse-acting type is specified.

SPECIFICATIONS

ACTUATOR ASSEMBLY

Nominal Size: 10 sq. in.
Action: Direct acting Increasing air pressure moves stem downward.
Nominal Travel: 3/8" (9.6 mm)
Maximum Air Pressure: 30 psi (2.0 bar)
Maximum Ambient Temperature: 180°F. (82°C.)
Air Connection: 1/8" NPT, female

Materials of Construction:

Diaphragm Molded EPDM
Housing & Frame Die cast aluminum, irridite finished for corrosion resistance, painted bronzeless gold.
Spring Zinc plated alloy steel

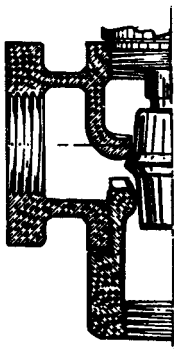

Typical Full-Ported Inner Valves

3-Way BN Brass Plug on Integral Brass Seat

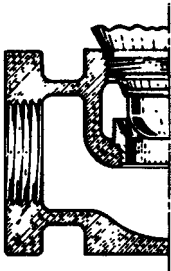

BJ, BL Teflon O-Ring Seating

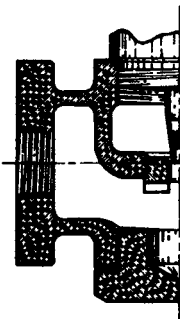

BH Top Guided

VALVE ASSEMBLY

Action:

Direct (Provides air-to-close action with actuator)
Reverse (Provides air-to-open action with actuator)
3-way (Top port normally closed)

Valve Body Assembly Ratings:

100 psi at 350°F. (6.9 bar at 177° C.)

End Connections: Female NPT inlet and outlet.

Seal Ring: 316 Stainless Steel, replaceable in 2-way body. Integral brass seats in 3-way body.

Materials of Construction:

Body Brass
Trim 316 Stainless Steel in 2-way valves. Brass in 3-way valves.
Primary Packing Nickel plated beryllium copper bellows.
Secondary Packing Buna-N "O" ring.

ACCESSORIES

VC-210B Control Valves are available with the Model P-2 positioner or No. 84589-A2, 110 VAC solenoid valve mounted on the valve and prepped to the actuator.

INNER VALVE CONSTRUCTION

These illustrations represent 3-way and direct-acting body styles. The Teflon O-ring construction is also available in reverse-acting styles (See TABLE I).

TABLE I
2-WAY VALVES

Valve Style		Valve Body Material	Flow Characteristics	Seating Style	Trim Materials	Valve Size, In.	Cv	
Direct Acting	Reverse Acting						DA	RA
BJ	BJR	Brass	Quick Opening	Teflon* O-Ring	316 Stainless Steel	1/2	4.0	4.0
						3/4	8.0	8.0
						1	9.0	8.5
BL	BLR	Brass	Equal Percentage	Teflon* O-Ring	316 Stainless Steel	1/2	2.0	2.0
						3/4	7.5	8.0
						1	8.5	8.5
BH		Brass	Linear	Stainless Steel Needle Plug	316 Stainless Steel	1/2	0.3	N.A.
							0.6	

3-WAY VALVES

BN	Brass	Linear	Brass Plug on Integral Brass Seat	Brass	1/2	2.2
					3/4	4.6
					1	9.0

*Teflon is registered trademark of DuPont Co.

DIMENSIONS, SHIPPING WEIGHTS

(All dimensions in inches (mm)).

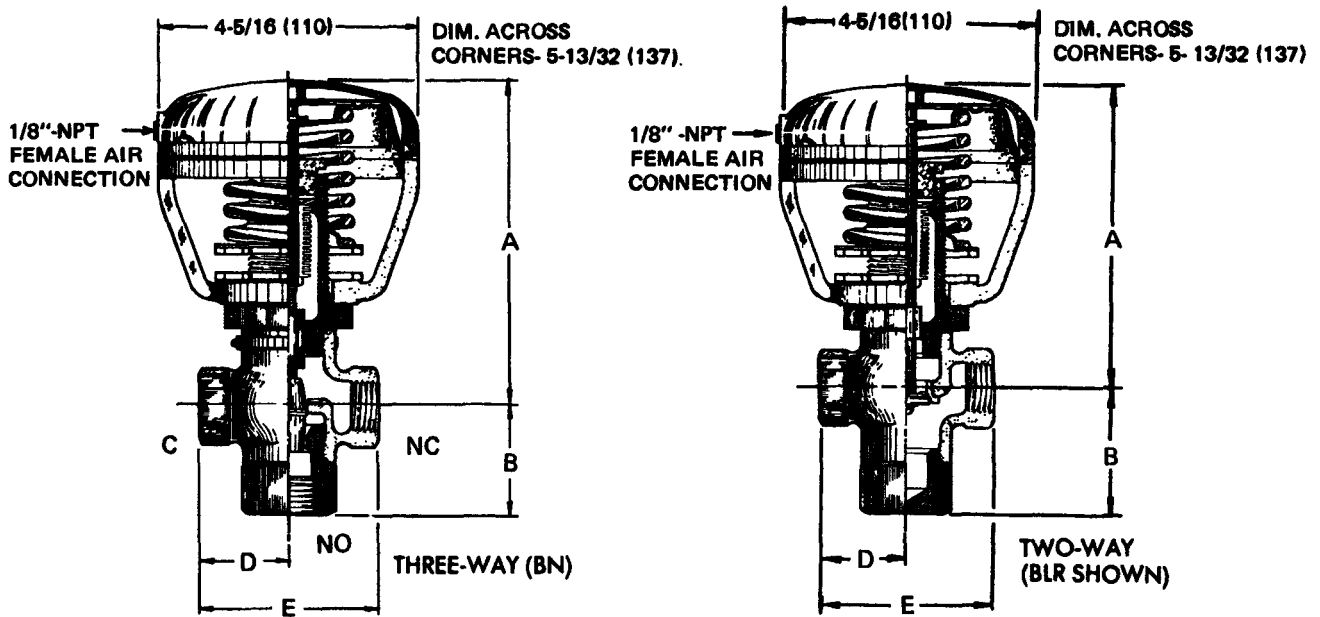

TABLE II

Valve Style	Pattern	Body Material	Dimension	Valve Size, In.		
				1/2	3/4	1
BJ BJR BL BLR	Two-way	Brass	A	5 (127)	5-1/4 (133)	5-1/4 (133)
			B	1-19/32 (40.5)	1-15/16 (49.2)	1-15/16 (49.2)
			D	1-1/2 (38.1)	2 (50.8)	2 (50.8)
			E	3 (76.2)	4 (102)	4 (102)
BN	Three-way	Brass	A	5-5/16 (135)	5-5/16 (135)	5-13/16 (148)
			B	1-3/4 (44.5)	2-5/32 (54.8)	3-7/32 (81.8)
			D	1-1/2 (38.1)	2 (50.8)	2-1/2 (63.5)
			E	3 (76.2)	4 (102)	5 (127)
BH	Two-way	Brass	A	5-3/8 (137)	-	-
			B	1-3/4 (44.5)	-	-
			D	1-1/2 (38.1)	-	-
			E	3 (76.2)	-	-
All Styles			Shipping Wgt., Lbs. (kg)	4-3/4 (2.1)	6-1/4 (2.8)	9 (4.1)

MAXIMUM ALLOWABLE PRESSURE DROP

When the control valve is required to close off against the full upstream pressure with 0 psig on the downstream side of the valve, the upstream pressure should be considered as the maximum pressure drop. The tabulated maximum pressure drops are for throttling service only. Where rapid cycling or on-off type service is the application, the pressure differential across a VC-210B control valve should not exceed 50 psi (3.45 bar). In any case the upstream pressure should not exceed 100 psi (6.89 bar). The tabulated ratings are based on 3-15 (0.2-1.0 bar) signal.

TABLE III

Nominal Valve Size	BENCH TEST SPRING RANGES †						
	AIR-TO-CLOSE		AIR-TO-OPEN			3-WAY	
	3 - 12 psi* (0.2 - 0.8 bar)	3 - 7 psi (0.2 - 0.5 bar)	6 - 15 psi* (0.4 -1.0 bar)	8 - 15 psi (0.55 -1.0 bar)	11 - 15 psi (0.75 -1.0 bar)	5 - 14 psi* (0.3 - 0.9 bar)	9 - 13 psi (0.6 - 0.9 bar)
MAX. ALLOWABLE PRESSURE DROP							
1/2	90	100	100	100	100	60	100
3/4	50	100	100	100	100	35	80
1	30	90	50	80	100	20	40

*Standard Springs † Bench Test with 0 psi in valve body.

ORDERING INFORMATION

Specify:

1. Complete Model No.

Example: 1/2" VC-210B-BL (for air to close control valve).
3/4" VC-210B-BLR (for air to open control valve).

2. Quantity
3. Bench test spring range required. (If other than standard).
See TABLE III.
4. Medium through valve.
5. Upstream Pressure
6. Pressure drop
7. Shipping and billing instructions



Robertshaw Industrial Products
1602 Mustang Drive
Maryville, Tennessee 37801
Phone: (865) 981-3100 Fax: (865) 981-3168
<http://www.robertshawindustrial.com>